



# EUROPEAN ANTENNAS



## CIRCULAR POLARISED OMNI ANTENNA

MODEL: RC05-3450-M01/518

FREQUENCY: 3.35 - 3.55 GHz	GAIN: 5 dBiC
POLARISATION: R.H. Circular	BEAMWIDTH: 360° x 40°
AXIAL RATIO: 2 - 3 dB Typical	VSWR: 1.5 : 1
POWER RATING: 10 W	FRONT TO BACK: N/A
TEMPERATURE: -20°C to +50°C	MASS: 600 g
RADOME: Glass Fibre/Gloss White	WIND LOADING: 3.4Kg/7.6lbs @100mph

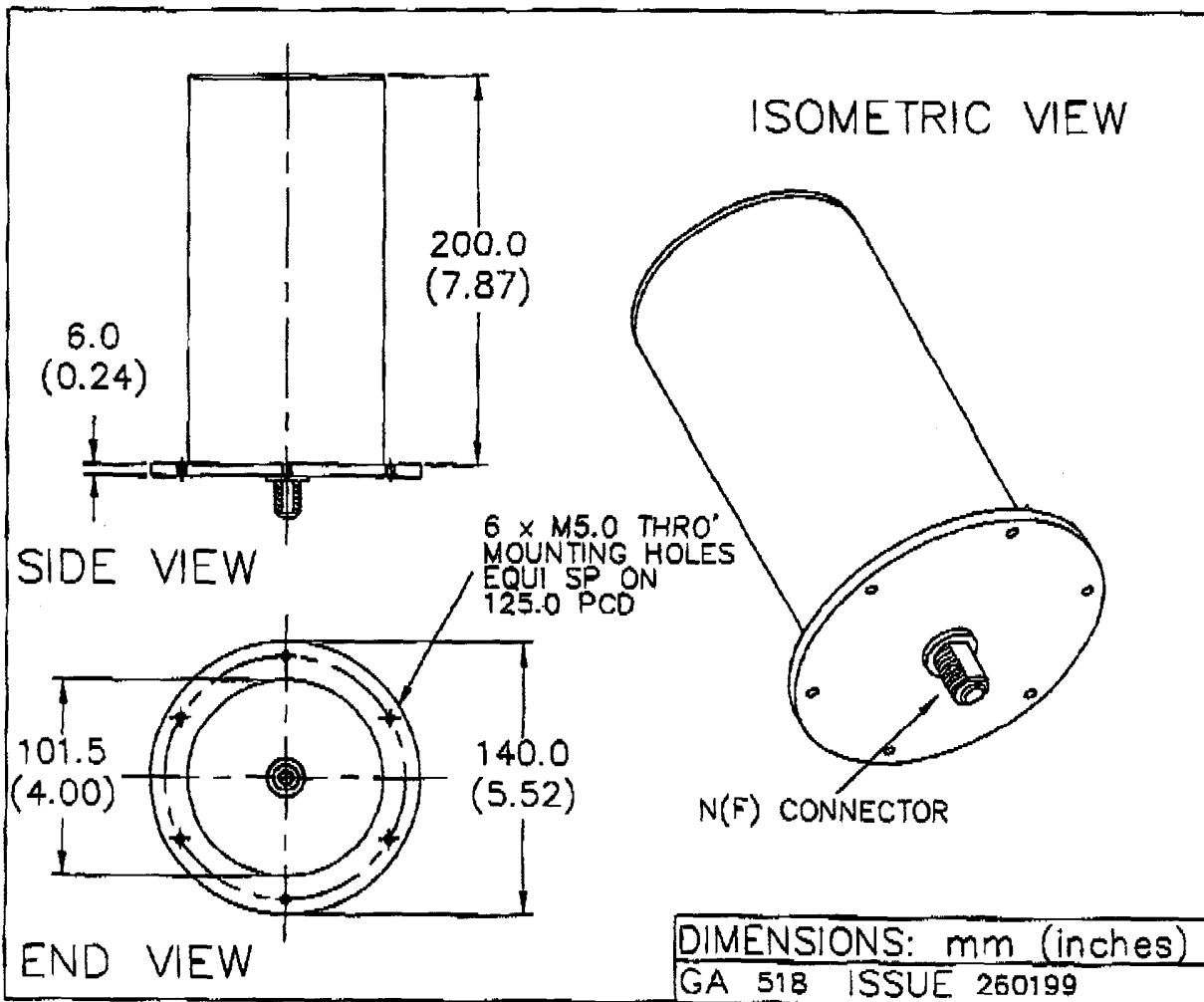

EUROPEAN ANTENNAS LTD.

TEL: +44 (0)1638 731888

LAMBDA HOUSE, CHEVELEY,  
NEWMARKET, SUFFOLK. CB8 9RG,  
UNITED KINGDOM.

FAX: +44 (0)1638 731999

European Antennas Ltd. has a policy of continuous development and therefore stress that the data contained on this sheet should be used for guidance only.



# EUROPEAN ANTENNAS



## CIRCULAR POLARISED OMNI ANTENNA

MODEL: RC05-2450/156

FREQUENCY: 2.40 - 2.55 GHz	GAIN: 5 dBic
POLARISATION: R.H. Circular	BEAMWIDTH: 360° X 40°
AXIAL RATIO: 2 dB Typical	VSWR: 1.5 : 1
POWER RATING: 10 W	FRONT TO BACK: N/A
TEMPERATURE: -20°C to +50°C	MASS: 0.8 Kg/1.76 lbs
RADOME: Glass Fibre/Gloss White	WIND LOADING: 4.0Kg/8.8lbs @100mph

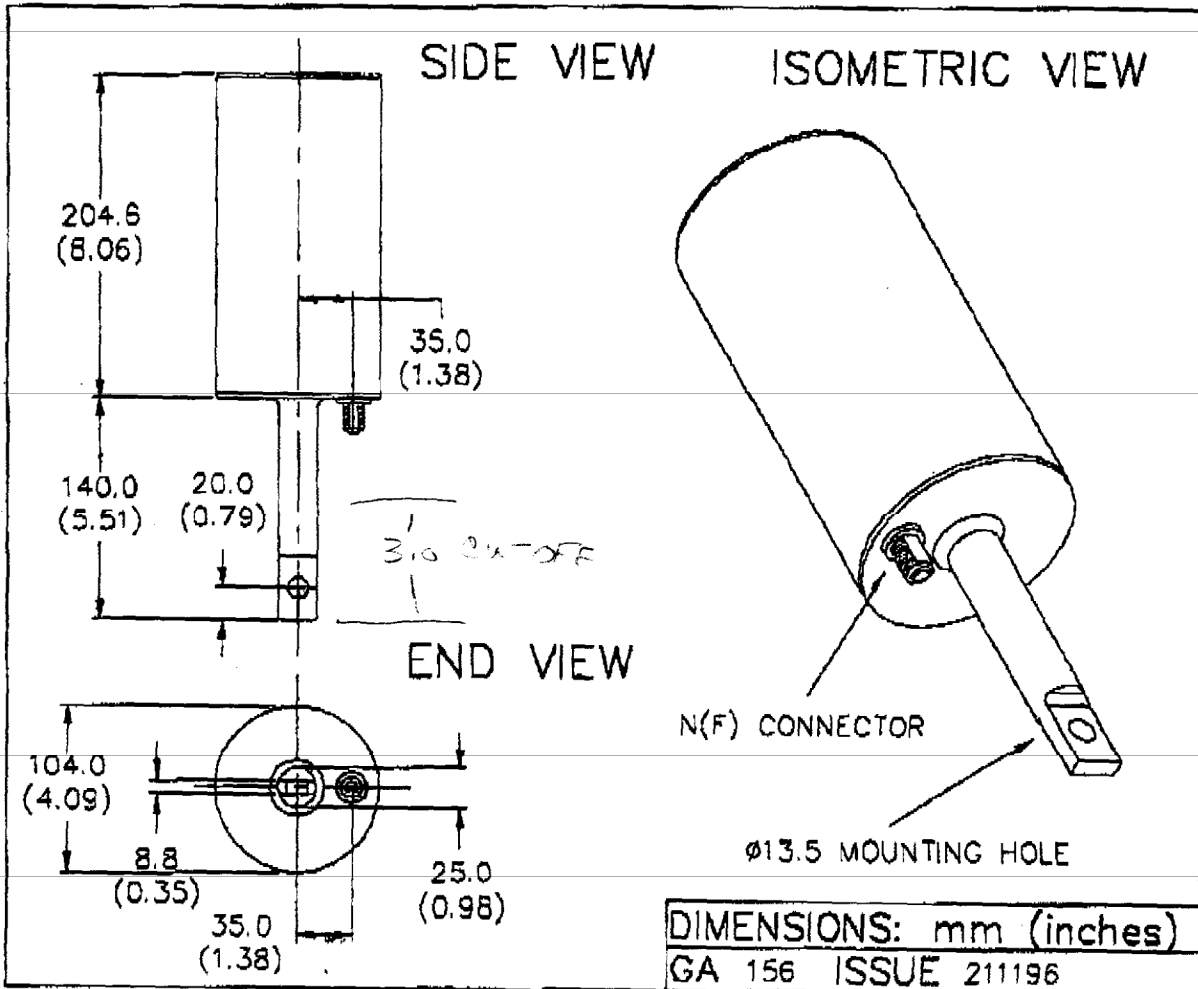

EUROPEAN ANTENNAS LTD.

TEL: +44 (0)1636 731888

LAMBDA HOUSE, CHEVELEY,  
NEWMARKET, SUFFOLK, CB8 9RG,  
UNITED KINGDOM.

FAX: +44 (0)1638 731999

European Antennas Ltd. has a policy of continuous development and therefore stress that the data contained on this sheet should be used for guidance only.